

maj 2010



Center Republike Slovenije za poklicno izobraževanje
Institute of the Republic of Slovenia for Vocational Education and Training

PRIROČNIK CELOSTNE GRAFIČNE PODOBE
CORPORATE GRAPHICS DESIGN MANUAL

Znak: osnovna oblika in zasnova

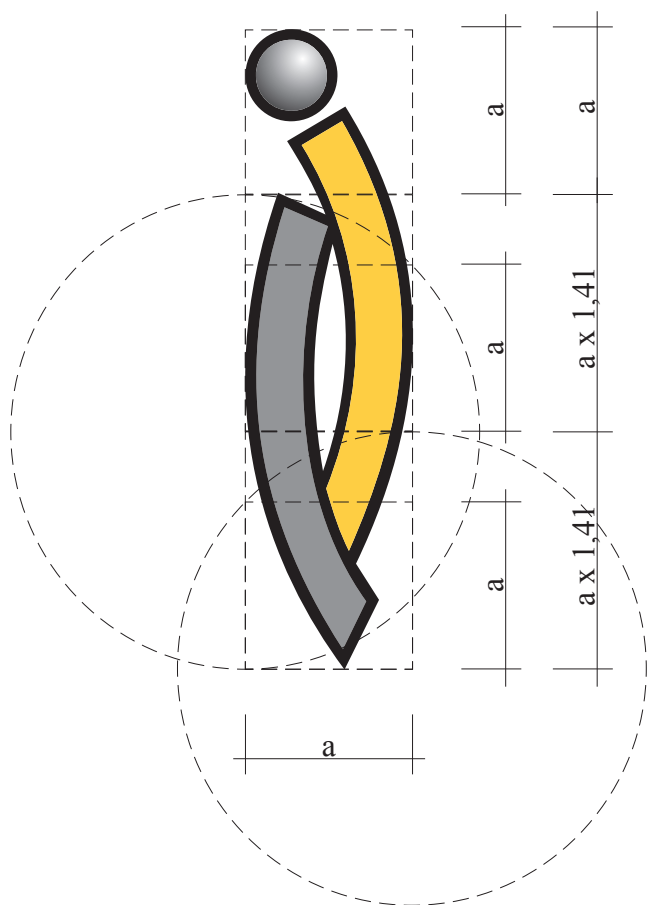

barvna, sivinska, enobarvna in inverzna izvedba

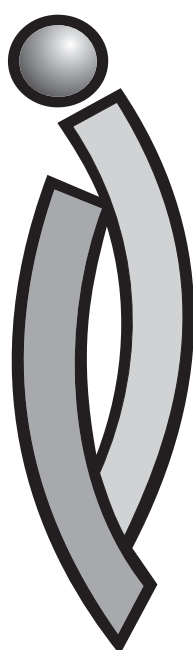
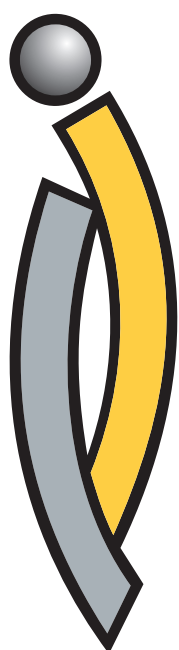

Znak: dopolnjena oblika

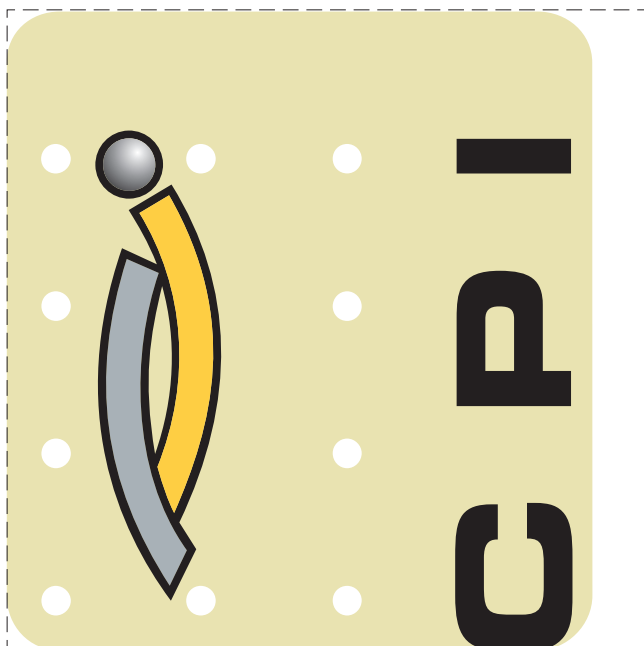

barvna, sivinska, enobarvna in inverzna izvedba

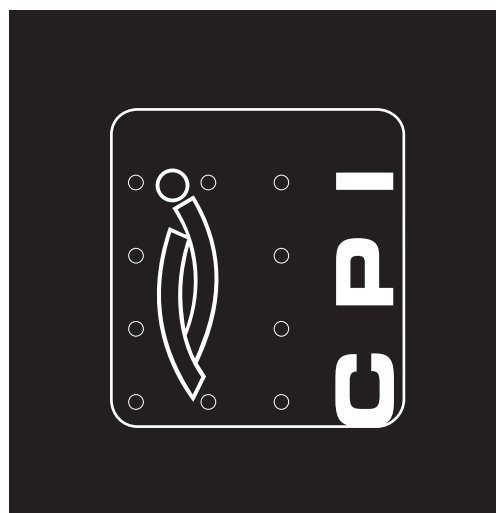
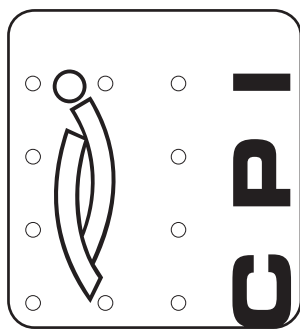
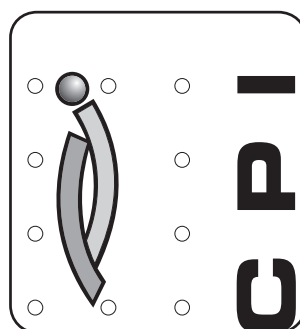

Znak: osnovna oblika - polje nedotakljivosti

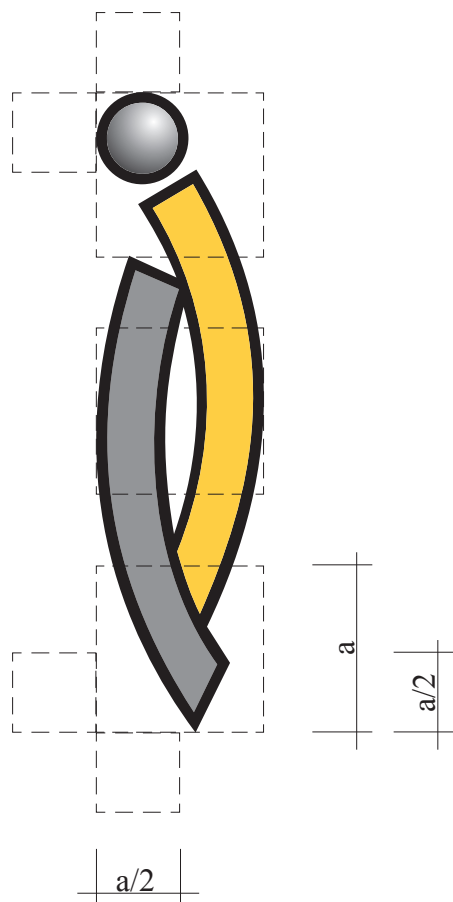

Logotip: dopolnjena oblika - polje nedotakljivosti

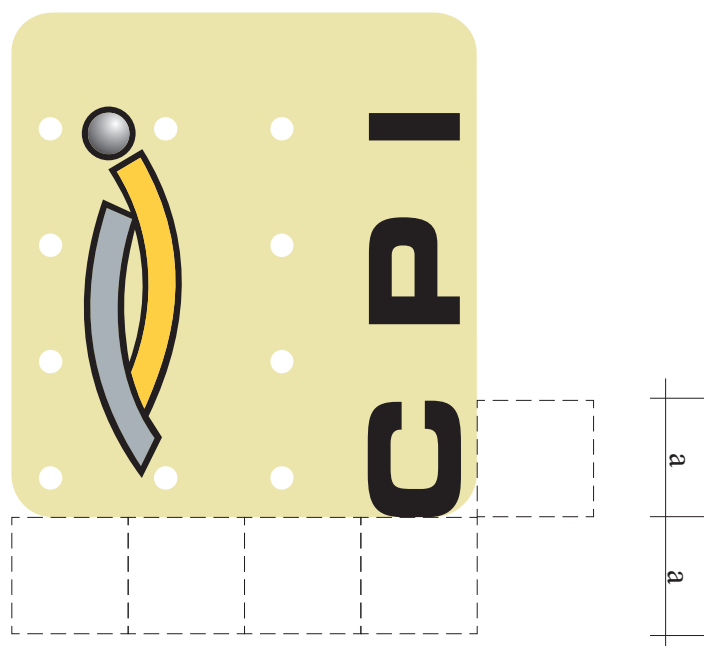

Znak: barve

barvna različica



Pantone:

CMYK:
C20, M20, Y20, K100



Pantone:
Pantone 616

CMYK:
C 0, M 0, Y 34, K 9



Pantone:
Pantone 122

CMYK:
C 0, M 19, Y 83, K 0



Pantone:
Pantone 429

CMYK:
C 6, M 0, Y 0, K 34

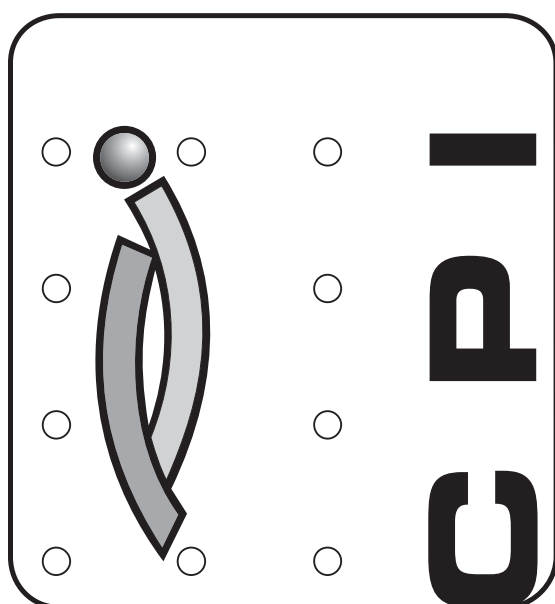

sivinska različica



Pantone:
Pantone Cool Gray 3C

CMYK:
C 0, M 0, Y 0, K 15



Pantone:
Pantone Cool Gray 7C

CMYK:
C 0, M 0, Y 0, K 50

Znalk in napis: barve

**Center
Republike Slovenije
za poklicno
izobraževanje**



**Center Republike Slovenije
za poklicno izobraževanje**

Ob železnici 16, 1000 Ljubljana

tel.: **01/5864 200**

faks: **01/5422 045**

e-pošta: **cpi@cpi.si**

www.cpi.si



**Institute
of the Republic of Slovenia
for Vocational Education
and Training**



**Institute of the Republic of Slovenia
for Vocational Education and Training**

Ob železnici 16, SI-1000 Ljubljana, Slovenia

phone: + **386 (0)1/5864 200**

fax: + **386 (0)1/5422 045**

e-mail: **cpi@cpi.si**

www.cpi.si



Znalk in napis: sivinsko

Center Republike Slovenije za poklicno izobraževanje

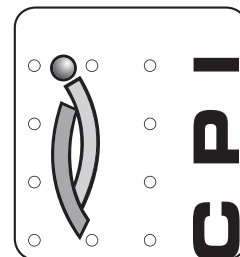

**Center Republike Slovenije
za poklicno izobraževanje**

Ob železnici 16, 1000 Ljubljana

tel.: **01/5864 200**

faks: **01/5422 045**

e-pošta: **cpi@cpi.si**

www.cpi.si

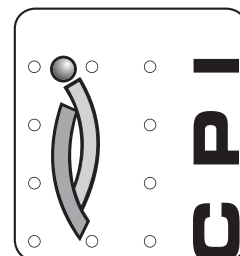

Institute of the Republic of Slovenia for Vocational Education and Training

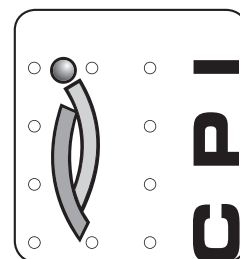

**Institute of the Republic of Slovenia
for Vocational Education and Training**

Ob železnici 16, SI-1000 Ljubljana, Slovenia

phone: + **386 (0)1/5864 200**

fax: + **386 (0)1/5422 045**

e-mail: **cpi@cpi.si**

www.cpi.si

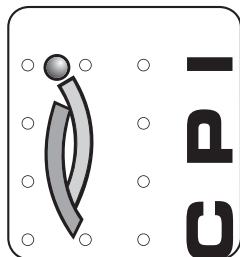

Znalk in napis: enobarvne rešitve

Center Republike Slovenije za poklicno izobraževanje

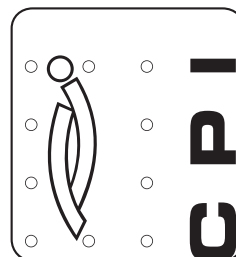

Center Republike Slovenije za poklicno izobraževanje

Ob železnici 16, 1000 Ljubljana

tel.: **01/5864 200**

faks: **01/5422 045**

e-pošta: **cpi@cpi.si**

www.cpi.si

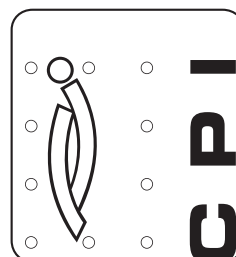

Institute of the Republic of Slovenia for Vocational Education and Training

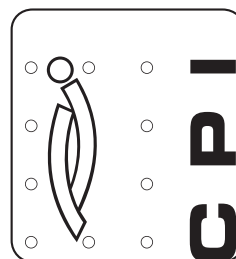

Institute of the Republic of Slovenia for Vocational Education and Training

Ob železnici 16, SI-1000 Ljubljana, Slovenia

phone: + **386 (0)1/5864 200**

fax: + **386 (0)1/5422 045**

e-mail: **cpi@cpi.si**

www.cpi.si

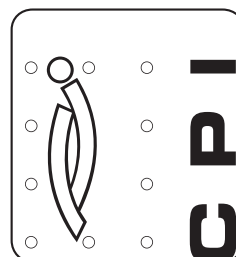

**Center
Republike Slovenije
za poklicno
izobraževanje**

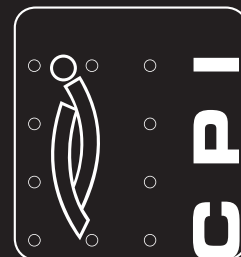

**Center Republike Slovenije
za poklicno izobraževanje**

Ob železnici 16, 1000 Ljubljana

tel.: **01/5864 200**

faks: **01/5422 045**

e-pošta: cpi@cpi.si

www.cpi.si

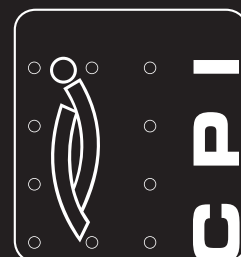

**Institute
of the Republic of Slovenia
for Vocational Education
and Training**

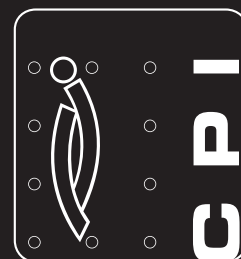

**Institute of the Republic of Slovenia
for Vocational Education and Training**

Ob železnici 16, SI-1000 Ljubljana, Slovenia

phone: + **386 (0)1/5864 200**

fax: + **386 (0)1/5422 045**

e-mail: cpi@cpi.si

www.cpi.si

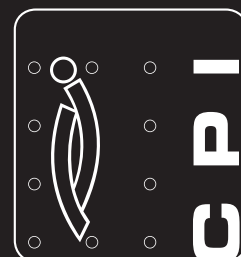

Tipografija:

Eurostile Regular Extended:

ABCČDEFGHIJKLMNOPŠŤUVZXYŽ
abcčdefghijklmnopsštuvzxyž
1234567890.,;'"&!?

Eurostile Black Extended:

ABCČDEFGHIJKLMNOPŠŤUVZXYŽ
abcčdefghijklmnopsštuvzxyž
1234567890.,;'"&!?